

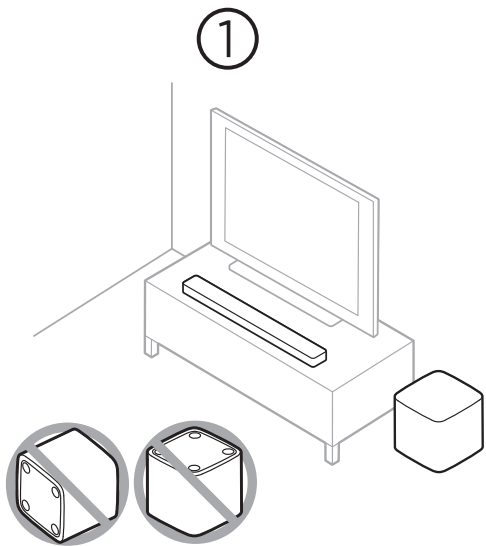

BASS MODULE 700

Please read and keep all safety and use instructions.



Place the bass module

Keep at least 1 - 3 ft. (0.3 - 0.9 m) away from other wireless equipment.

②

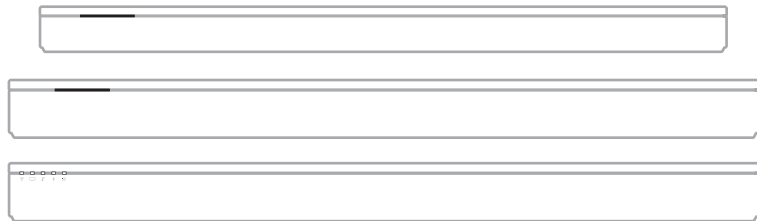

Choose your setup method

Your setup method depends on which soundbar you have.

Bose® Soundbar 500 or Bose Soundbar 700: See Method 1.

SoundTouch® 300 soundbar: See Method 2.

METHOD 1

BOSE® SOUNDBAR 500 OR BOSE SOUNDBAR 700



Set up using the Bose Music app

- In the Bose Music app, from the **My Bose** screen, tap your soundbar.
- Tap the soundbar image in the bottom-right corner of the screen.
- Tap **Settings > Accessory Speakers > Add Bose Accessory Speakers**.

New to the Bose Music app?

Download the app and follow the app instructions to set up your soundbar and bass module.

METHOD 2

SOUNDTOUCH® 300 SOUNDBAR

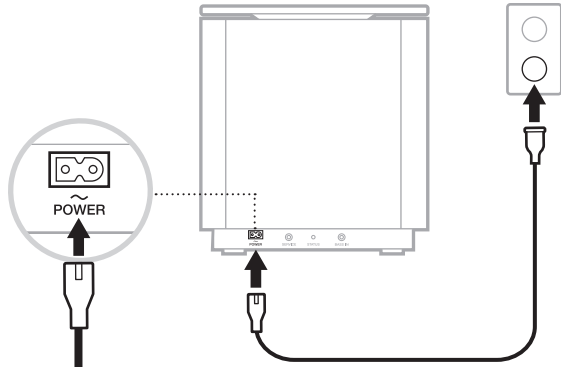

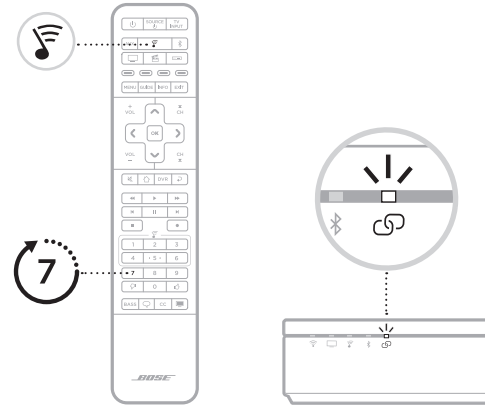

Connect the bass module to power

Once connected, the bass module powers on.



Connect the bass module to the soundbar

- On your SoundTouch® 300 remote control, press .
- Press and hold 7 until  on the soundbar blinks white. Once the bass module connects, you hear a tone and  glows white.

NOTE: Connecting may take several minutes.

METHOD 2 (CONTINUED)

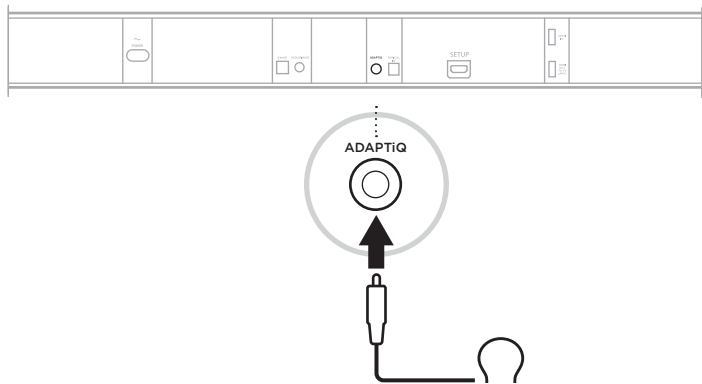



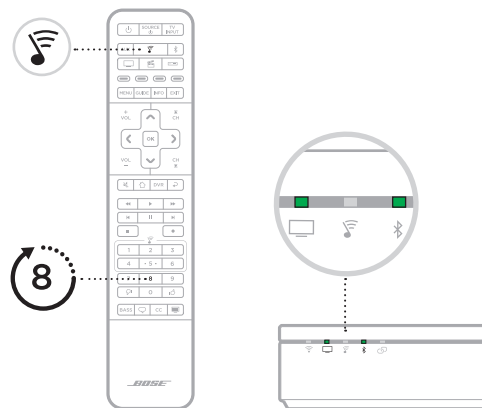

Set up ADAPTiQ® audio calibration

- Connect the ADAPTiQ headset (included with the soundbar) to the soundbar's ADAPTiQ connector.
- Put the headset on your head.



Run ADAPTiQ® audio calibration

- On your SoundTouch® 300 remote control, press .
- Press and hold 8 until  and  on the soundbar glow green.

NOTE: To cycle through languages, press  and  on the navigation pad.

Lea y conserve todas las instrucciones de uso y seguridad.

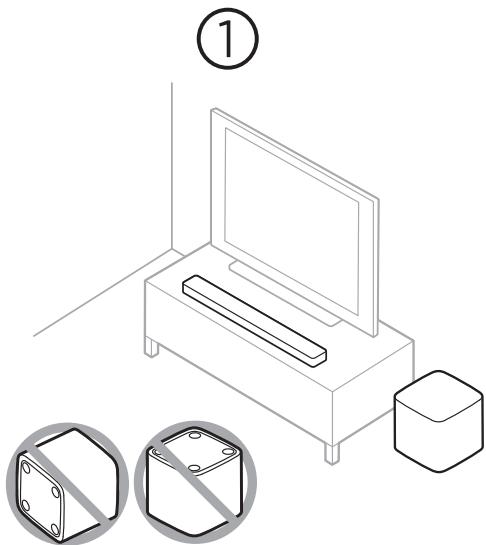

Colocación del módulo de bajos

Manténgalo a una distancia de 0,3 a 0,9 m de otros equipos inalámbricos.

②

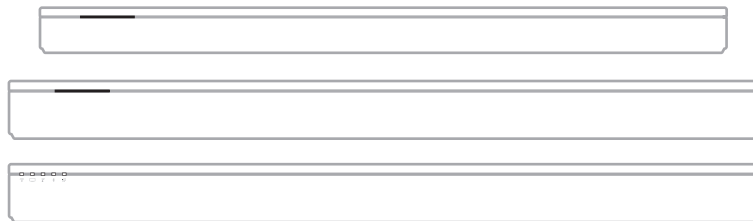

Elegir el método de configuración

El método de configuración depende de la barra de sonido que tenga.

Bose® Soundbar 500 o Bose Soundbar 700: Vea el método 1.

Barra de sonido SoundTouch® 300: Vea el método 2.

MÉTODO 1

BOSE® SOUNDBAR 500 O BOSE SOUNDBAR 700



Configurar usando la aplicación Bose Music

- En la aplicación Bose Music, en la pantalla **Mi Bose**, toque la barra de sonido.
- Toque la imagen de la barra de sonido en la esquina inferior derecha de la pantalla.
- Toque **Configuración > Altavoces accesorios > Agregar altavoces accesorios Bose**.

¿Es la primera vez que usa la aplicación Bose Music?

Descargue la aplicación y siga las instrucciones de la aplicación para configurar la barra de sonido y el módulo de bajos.

MÉTODO 2

BARRA DE SONIDO SOUNDTOUCH® 300

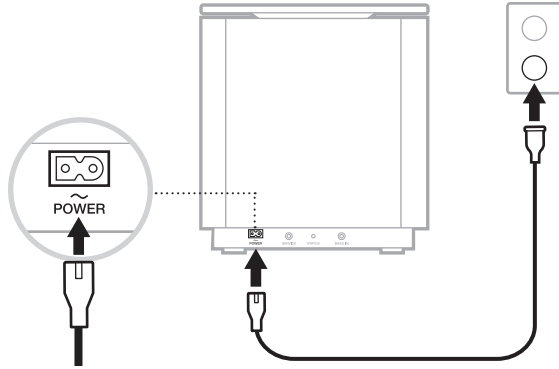



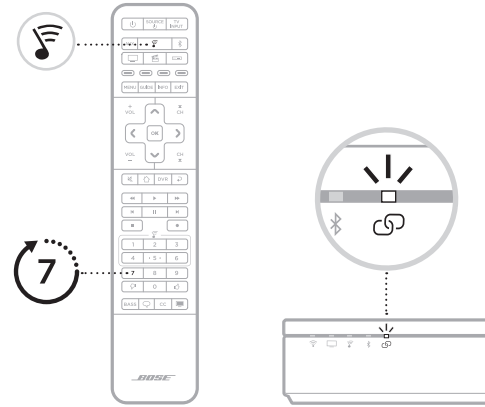

Conecte el módulo de bajos a la fuente de alimentación

Una vez conectado, el módulo de bajos se enciende.



Conectar el módulo de bajos a la barra de sonido

- En el control remoto del SoundTouch® 300, presione .
- Mantenga presionado  hasta que  en la barra de sonido parpadea de color blanco.
Una vez que se conecta el módulo de bajos, se oye un tono y  se ilumina de color blanco.

NOTA: La conexión puede tardar varios minutos.

MÉTODO 2 (CONTINUACIÓN)

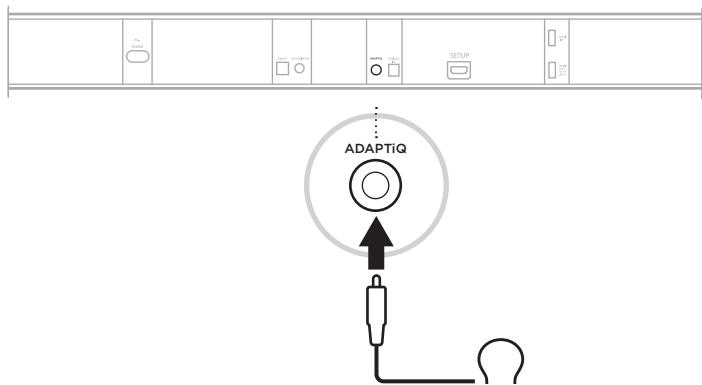



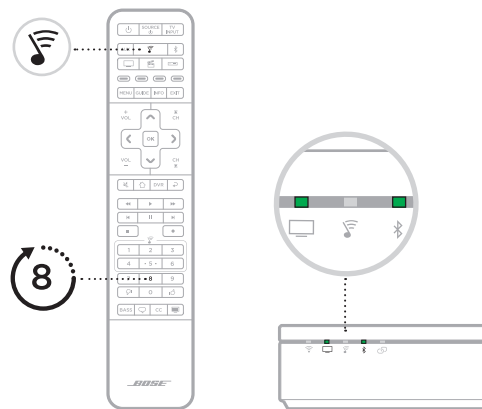

Configurar la calibración de audio ADAPTiQ®

- Conecte los auriculares ADAPTiQ (incluidos con la barra de sonido) al conector ADAPTiQ de la barra de sonido.
- Colóquese los auriculares



Ejecutar la calibración de audio ADAPTiQ®

- En el control remoto de SoundTouch® 300, presione .
- Mantenga presionado 8 hasta que  y  en la barra de sonido se iluminan de color verde.

NOTA: Para cambiar entre los distintos idiomas, presione  y  en el panel de navegación.

Lisez toutes les consignes de sécurité et les instructions d'utilisation.

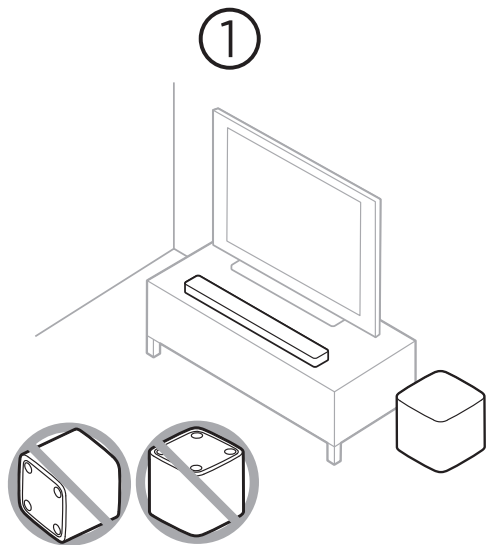

Positionnement du module de graves

Éloignez la barre de son de 0,3 à 0,9 m de tout autre appareil sans fil.

②



Sélection de la méthode de configuration

La méthode de configuration dépend de votre barre de son.

Barre de son Bose® Soundbar 500 ou Bose Soundbar 700 :
voir la Méthode 1.

Barre de son SoundTouch® 300 Soundbar : voir la Méthode 2.

MÉTHODE 1

BARRE DE SON BOSE® SOUNDBAR 500 OU BOSE SOUNDBAR 700



Configuration à l'aide de l'application Bose Music

- Dans l'application Bose Music, appuyez sur votre barre de son dans l'écran **Mon Bose**.
- Appuyez sur l'image représentant la barre de son située dans l'angle inférieur droit de l'écran.
- Appuyez sur **Paramètres > Enceintes accessoires > Ajouter les enceintes accessoires Bose**.

Vous découvrez l'application Bose Music ?

Téléchargez l'application et suivez les instructions pour configurer votre barre de son et votre module de graves.

MÉTHODE 2

BARRE DE SON SOUNDTOUCH® 300

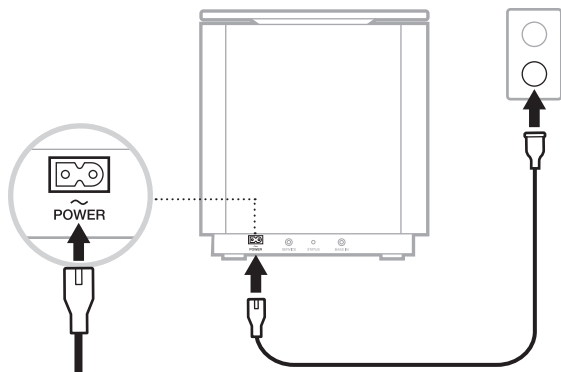

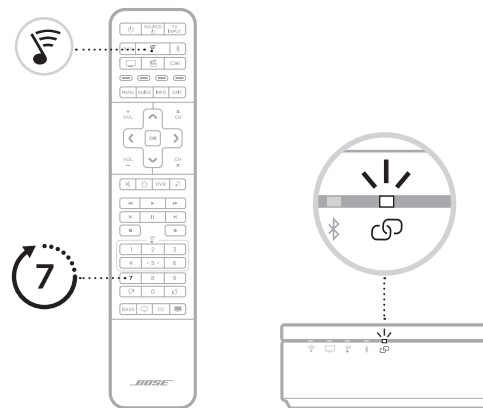

Raccordement du module de graves à la prise secteur

Une fois connecté, le module de graves se met sous tension.



Raccordement du module de graves à la barre de son

- Sur la télécommande de votre barre de son SoundTouch® 300, appuyez sur .
- Appuyez sur la touche 7 jusqu'à ce que l'indication  clignote en blanc sur la barre de son.

Une fois le module de graves connecté, vous entendez une tonalité et  s'allume en blanc.

REMARQUE : la connexion peut prendre plusieurs minutes.

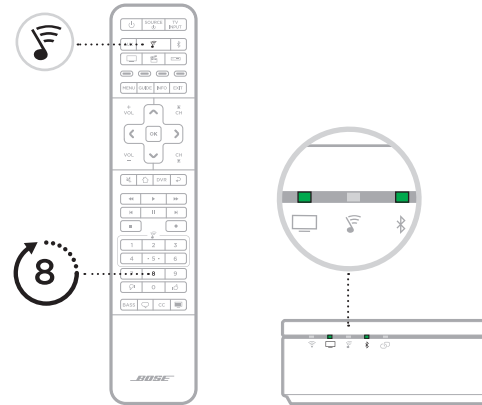
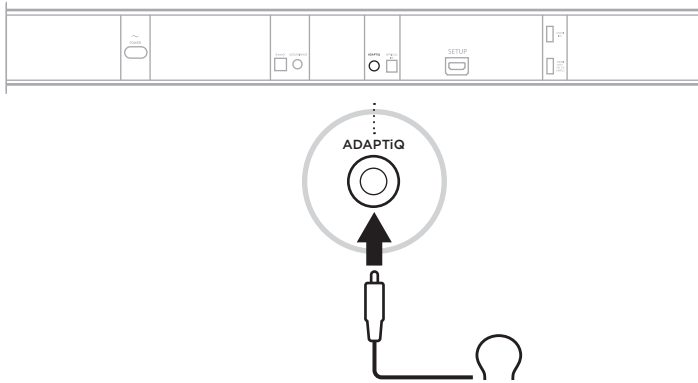

MÉTHODE 2 (SUITE)





Configuration de l'étalonnage audio ADAPTiQ®

- Raccordez le casque ADAPTiQ (fourni avec la barre de son) au connecteur ADAPTiQ de la barre de son.
- Placez le casque sur votre tête.

Exécution du calibrage audio ADAPTiQ®

- Sur la télécommande de votre barre de son SoundTouch® 300, appuyez sur .
- Appuyez sur la touche 8 jusqu'à ce que les indications  et  clignotent en vert sur la barre de son.

REMARQUE : pour parcourir les langues, appuyez sur les touches  et  du pavé de navigation.



worldwide.Bose.com/Support/BASS700



810742-0030